



MARLEY RP80[®]
80MM ROUND DOWNPIPE SYSTEM

STREAMLINED SIMPLICITY

Introducing the new Marley RP80[®]
80mm Round Downpipe System.



15 YEAR
GUARANTEE



WILL NOT
RUST



U.V
RESISTANT



MADE
IN NZ



SAFE FOR
DRINKING



LOW
MAINTENANCE



100%
RECYCLABLE

MARLEY RP80®

80mm ROUND DOWNPIPE SYSTEM

The Marley RP80® 80mm round downpipe system has set the standard in New Zealand for over 50 years, efficiently transferring rainwater from spouting to stormwater systems.

A streamlined new look has been developed with an easy-care gloss finish, compact curves and concealed sockets. This fresh approach gives the system a modern appeal and incorporates innovative new components that make the Marley RP80® system even faster and easier to install.

Now available in 6 colours, still made in NZ and guaranteed to last for 15 years, the new RP80® 80mm round downpipe system continues to set the standard.

Versatility

An extensive range of injection moulded RP80® fittings ensure a consistent high quality finish, minimise cutting and simplify even the most complex installations. The whole system is available in a range of colours or can be painted to match the roof, cladding or the general colour scheme of the home.

The RP80® system is able to be used with any of Marley's residential range of uPVC spouting and can combine with the coloured Typhoon® or Stormcloud® spouting range as part of the Marley Stratus Design Series®. It is also compatible with all metal spouting options available in New Zealand.

Keeping New Zealand Green

The Marley RP80® 80mm round downpipe system is certified for use with drinking water (AS/NZS 4020) and can be used with Marley rainwater accessories to help prevent debris from blocking drains, direct rainwater into storage for re-use and improve the quality of rainwater collected.

The entire system is also 100% recyclable, BEP-certified and made locally in New Zealand further reducing the environmental impact.

Tough and Long Lasting

Marley RP80® 80mm round downpipe is manufactured from uPVC. It is an extremely tough and long-lasting material that will not rust, requires little maintenance and is UV resistant. All RP80® components come with a 15-year guarantee.

Colour Availability



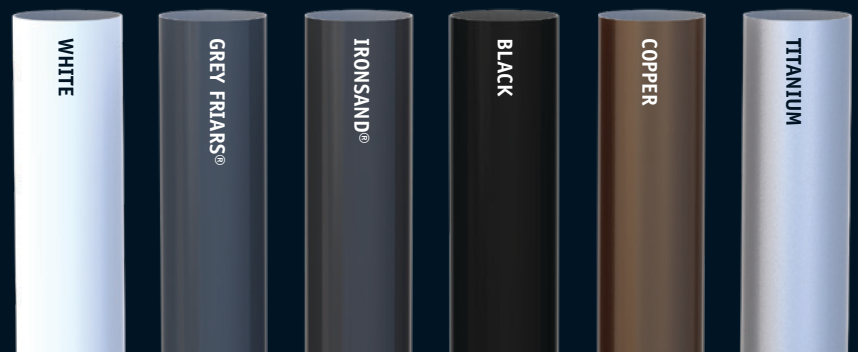





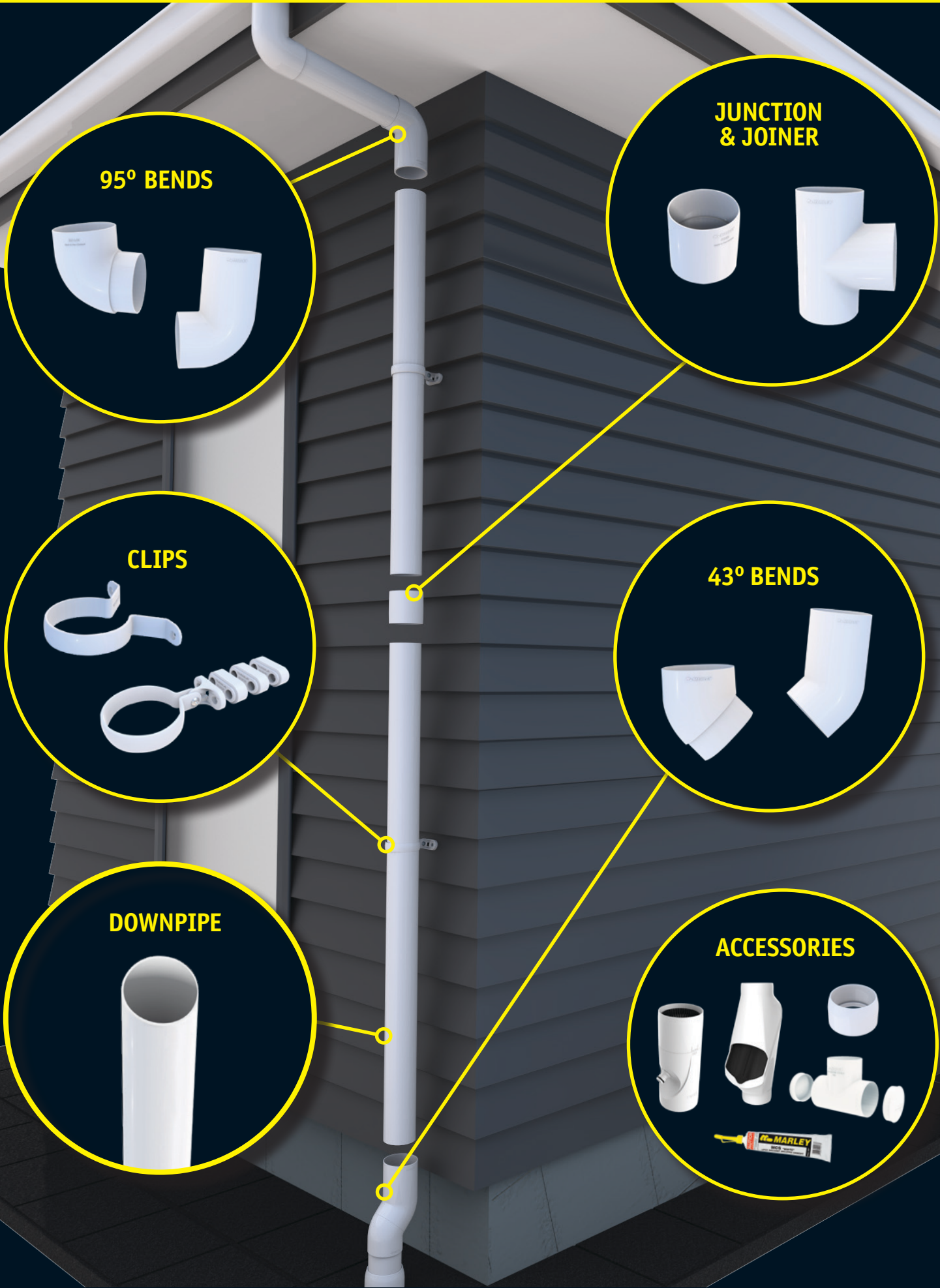

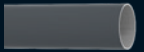



The Marley RP80® 80mm round downpipe system is available in White, Grey Friars®, Ironsand®, Black, Titanium and Copper.



Actual colours may vary slightly from those shown. For a more accurate colour comparison, please request a product sample.

SYSTEM OVERVIEW



	WHITE	GREY FRIARS®	IRONSAND®	BLACK	COPPER	TITANIUM
DOWNPIPE 3M (only white socketed at one end)	 RP80	 RP80.GYF	 RP80.IRO	 RP80.BLK	 RP80.COP	 RP80.TTN
95° F+F BEND	 RB2.80	 RB2.80.GYF	 RB2.80.IRO	 RB2.80.BLK	 RB2.80.COP	 RB2.80.TTN
43° F+F BEND	 RB3.80	 RB3.80.GYF	 RB3.80.IRO	 RB3.80.BLK	 RB3.80.COP	 RB3.80.TTN
95° M+F BEND	 RB4.80	 RB4.80.GYF	 RB4.80.IRO	 RB4.80.BLK	 RB4.80.COP	 RB4.80.TTN
43° M+F BEND	 RB5.80	 RB5.80.GYF	 RB5.80.IRO	 RB5.80.BLK	 RB5.80.COP	 RB5.80.TTN
SADDLE PIPE CLIP	 RC80	 RC80.GYF	 RC80.IRO	 RC80.BLK	 RC80.COP	 RC80.TTN
ADJUSTABLE PIPE CLIP	 RC80.2	 RC80.2.GYF	 RC80.2.IRO	 RC80.2.BLK	 RC80.2.COP	 RC80.2.TTN
ADJUSTABLE PIPE CLIP SPACER	 RC80.2S	 RC80.2S.GYF	 RC80.2S.IRO	 RC80.2S.BLK	 RC80.2S.COP	 RC80.2S.TTN
JOINTING SOCKET	 RS80	 RS80.GYF	 RS80.IRO	 RS80.BLK	 RS80.COP	 RS80.TTN
95° JUNCTION	 RJ80	 RJ80.GYF	 RJ80.IRO	 RJ80.BLK	 RJ80.COP	 RJ80.TTN
DOWNPIPE SPREADER KIT	 SKIT80	 SKIT80.GYF	 SKIT80.IRO	 SKIT80.BLK	 SKIT80.COP	 SKIT80.TTN
END CAP	 CS80	 CS80.GYF	 CS80.IRO	 CS80.BLK	 CS80.COP	 CS80.TTN
ADAPTOR 80 TO 90mm	 RA80.90	 RA80.90.GYF	 RA80.90.IRO	 RA80.90.BLK	 RA80.90.COP	 RA80.90.TTN
ADAPTOR 80 TO 100mm	 RA80.100	 RA80.100.GYF	 RA80.100.IRO	 RA80.100.BLK	 RA80.100.COP	 RA80.100.TTN
MARLEY MCS® SOLVENT WELDING CEMENT	 MCS	 MCS.GYF	 MCS.IRO	 MCS.BLK	 MCS.COP	 MCS.TTN
CURVE™ LEAF DIVERTER	 CURVE	 CURVE.GYF	 CURVE.IRO	 CURVE.BLK	 CURVE.COP	 CURVE.TTN
TWIST® RAINWATER DIVERTER^	 TWIST	 TWIST.GYF	 TWIST.IRO	 TWIST.BLK	 TWIST.COP	 TWIST.TTN



Actual colours may vary slightly from those shown. For a more accurate colour comparison, please request a product sample.

DESIGN DETAILS

RP80® DOWNPIPE

- Easy care gloss finish
- Smooth internal bore to aid flow
- 3m lengths for easy transport
- Impact and UV resistance



RP80® BENDS

- Range of 95° and 43° bends with compact options
- Concealed tapered sockets and smooth curves
- Easily navigate short transitions down to 44mm
- Over-insertion safety stop on all sockets
- Improved flow characteristics
- Nominal 90° and 45° angles for simple transitions



Common Installation Scenarios

Traditional eaves gutter

The standard 95° or 43° bends achieve an outlet to wall transition with clean lines and minimal effort. Use RB3.80's for increased flow.

A] RB2.80 + RB2.80

B] RB3.80 + RB3.80

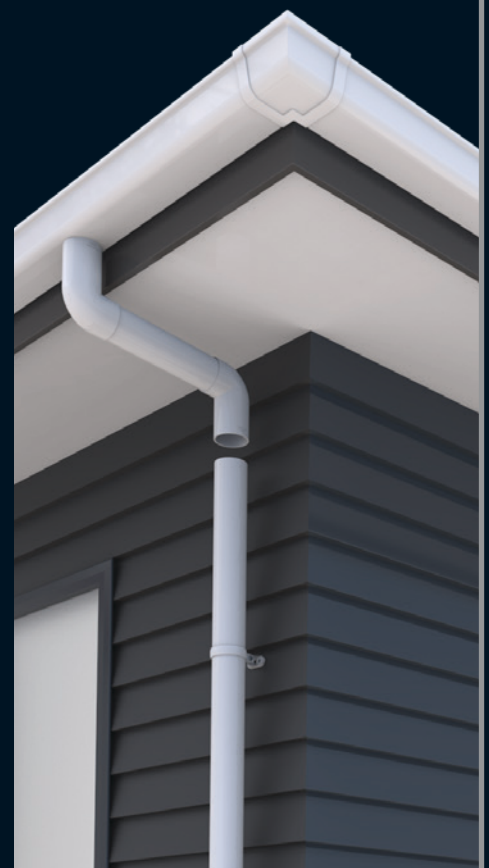

Narrow soffit

Combining the standard and compact bends allows a transition from outlet to wall using as little as 44mm without cutting or custom fabrication.

A] RB2.80 + RB4.80

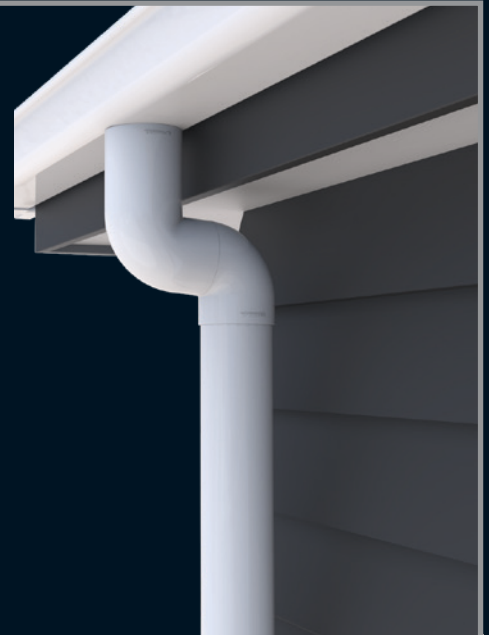
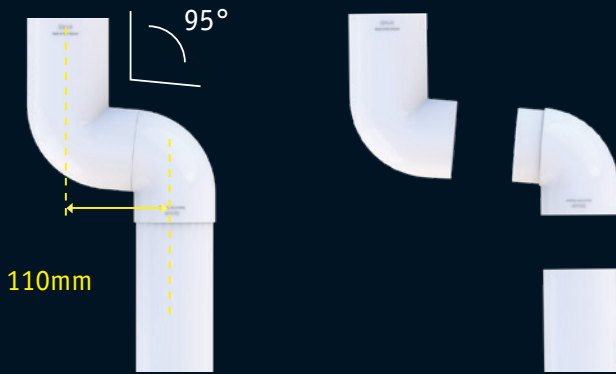

B] RB3.80 + RB5.80

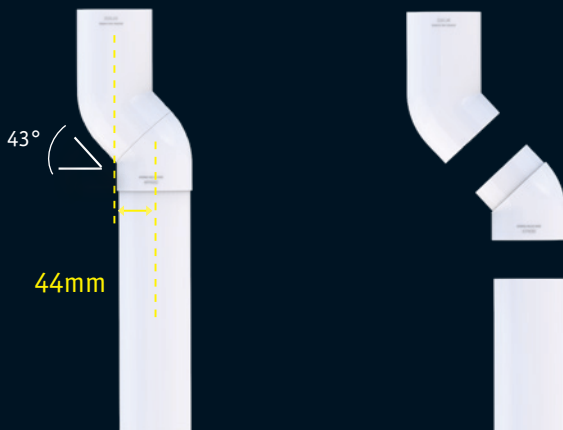

Stormwater outlet

Stormwater outlets that are out of alignment are easy to connect with Marley's new RP80® compact bends.

A] RB3.80 + RB5.80

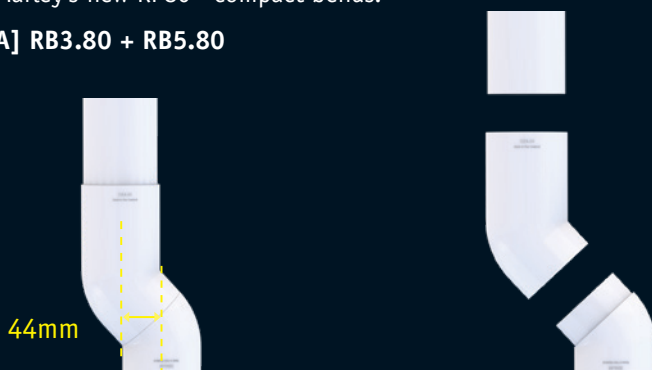

DESIGN DETAILS

RP80® CLIPS

- Streamlined aesthetic
- Versatility to use with a variety of wall claddings
- Strong and flexible design
- New pipe clip spacer (patent pending) allows easy horizontal spacing
- Date of manufacture stamp on both clips



RC80

Saddle Clip

- Fast installation
- Strong and flexible support



RC80.2

Adjustable Clip

- 180° vertical angular adjustment
- Horizontal adjustment
- Retained SS 316 nut/bolt system



RC80.2S

Adjustable Clip Spacer

- Used with adjustable pipe clips
- Unique interlocking design*
- Allows easy horizontal spacing (15mm per spacer)
- Sold separately

* NZ Pat Appl No. 618687

Common Installation Scenarios

Horizontal off-set

The RP80® clip systems provide simple flexible solutions to off-set the downpipe from the wall. The saddle clip features a standard 24mm offset while the adjustable clip and spacer system allows for a custom offset to suit your particular situation. This is often useful with multi-storey houses that feature variations in cladding material or garages with little or no soffit.

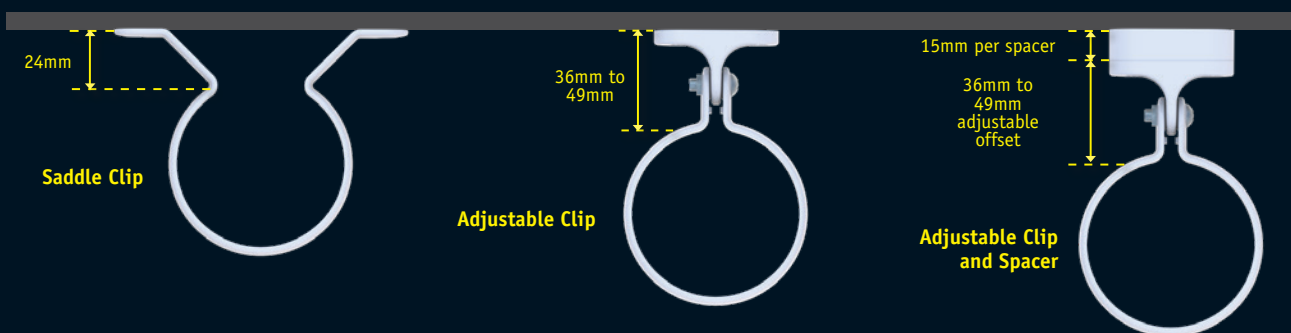

Angled cladding systems

The RC80.2 adjustable clip features 180° angular adjustment to fit your RP80® downpipe to any angled wall cladding surface such as weatherboard systems.

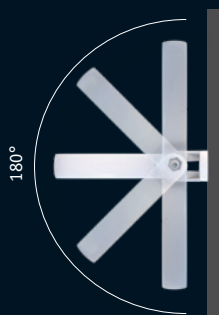

RP80® JOINER AND JUNCTION

- Clean lines and concealed tapered sockets
- Strong yet subtle connections
- Over-insertion safety stop on all sockets
- Standardised 'female' connections
- Use joiner as a female adaptor with M+F bends

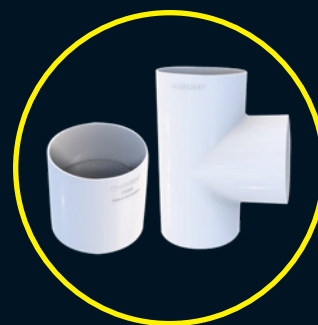

Common Installation Scenarios

Joining two sections of RP80® downpipe

Fast, strong and simple connection achieved with minimal effort. The RS80 joiner is a versatile fitting that can also connect directly to outlets or droppers to provide vertical extension for deep fascias or for non-socketed downpipe connections where no soffit exists.



Creating an RP80® downpipe junction

The RJ80 junction connects a downpipe discharging from an outlet into another downpipe. The 95° angle provides the necessary fall to promote good flow and the standardised 40mm female connections on all three sockets makes it simple to install.

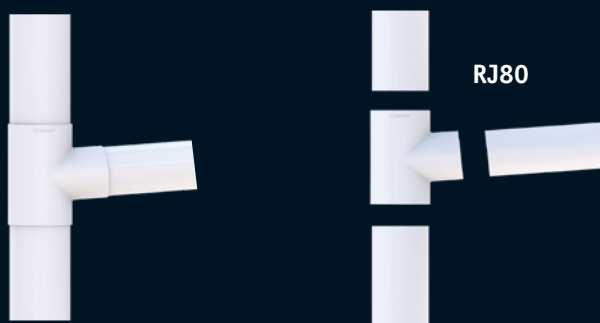

RP80® ACCESSORIES

Marley offers a range of RP80® accessories in all 6 colours to complete the system:

- Adaptors to connect downpipes to stormwater
- Curve and Twist rainwater harvesting products
- Colour-matched solvent cement to connect components
- Spreader kits to evenly distribute rainwater from upper roofs.



TECHNICAL INFORMATION

Diameter: 80mm (nominal size)

Material: uPVC
(Unplasticised PVC)



Maximum Roof Area per downpipe*

Roof Pitch	Maximum Roof Area served per downpipe (m ²)
0°–25°	100
25°–35°	80
35°–45°	70
45°–55°	60

*Based on average rainfall intensity of 100mm/hr

Clip System: Saddle or Adjustable pipe clips (and spacers).
To be spaced at max 1200mm centres (reduce to 900mm in high wind areas)

Use with Potable water:
The RP80® system is certified for use with drinking water as per the requirements of AS/NZS 4020

Environmental certification: ISO 14001, BEP certification

Compatible Marley Spouting systems: Classic®, Stormcloud®, FL2®, Typhoon®

NB. The Marley RP80® 80mm round downpipe system can be used in 'wet' or 'charged' systems that are subject to head pressure however should not be used inside wall or ceiling cavities. Care should be taken to ensure that all joints are sealed properly using Marley MCS solvent. Marley does not recommend uPVC downpipes be buried, instead Stormwater/DWV pipe should be used for this application.

Installation

Marley downpipe systems are intuitively designed as a modular system, making repair and replacement much simpler. However, there is a technical element to installing Marley downpipes so if you are unsure, Marley recommends you seek advice from a trade professional. Alternatively for a step by step guide refer to the DIY Nation section at www.marley.co.nz

Painting

Marley does not recommend the use of touch-up paint for its coloured RP80® systems. Air drying touch-up paints have different weathering characteristics to co-extruded uPVC coloured systems. Over time, the touch up paint will fade at a different rate to the co-extruded uPVC coloured systems, producing an unacceptable aesthetic appearance.

When painting a white RP80® downpipe system, the surface should first be washed with water and detergent. Once the surface is clean and dry, use a mineral-based undercoat to etch the spouting, followed by two coats of either acrylic or mineral based top coat. Paint only after installation.

Maintenance

To ensure your Marley RP80® 80mm round downpipe system maintains its good looks, it should be cleaned annually using warm soapy water and a car cleaning brush or cloth. Simply rinse off with clean water.



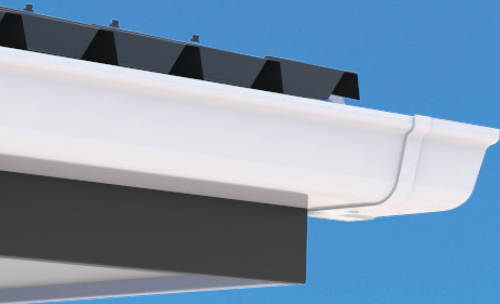

MARLEY GUARANTEE

Marley New Zealand Limited guarantees the purchaser of Marley spouting or downpipe products against defects in material and manufacture for a period of 15 years from the original date of purchase.

Marley New Zealand Limited (Marley) guarantees the purchaser of Marley spouting or downpipe products (Products) against defects in material and manufacture (Guarantee) for a period of 15 years from the original date of purchase (Guaranteed Period).

Conditions: This Guarantee is subject to the following conditions:

- The Products must be used only as external spouting and downpipes and are not suitable for use as a concealed system.
- The Products must be used and installed strictly according to the then current Marley published installation instructions as at the original date of purchase.
- If the Products are to be used in any application not covered by the then current Marley literature as at the original date of purchase, written confirmation of suitability must be obtained from Marley and a copy provided to Marley with any claim made under this Guarantee.
- Only Marley fittings and uPVC solvent cement (MCS) should be used in conjunction with the Products to ensure the integrity of the completed system.
- The Products must be maintained in accordance with the then current maintenance program available in Marley's Rainwater literature at the original date of purchase.

Failure to meet all the conditions set out above will deem this Guarantee invalid.

Exclusions: This Guarantee does not apply to:

- Any colour fading of the Products, including any colour fading caused by environmental conditions. Over time the Products will weather, as is customary with all exterior pigmented finishes. The rate at which fading occurs will be dependent on the environmental conditions the Product is exposed to, including UV levels, pollution and building orientation.
- Any Products modified, repaired or interfered with in any way other than by Marley or a Marley authorised person.
- Any Products purchased for the purposes of a business under the Consumer Guarantees Act 1993.
- Any defects in the Products caused by or resulting from causes not attributable to faulty material or manufacture, including defects caused by or resulting from any act or omission by the purchaser including misuse, neglect, incorrect installation or accidental damage.

Procedure

- Subject to the conditions and exclusions above, if during the Guaranteed Period you consider that our Guarantee has not been fulfilled, do not attempt repairs or replacement.
- Contact Marley with your claim in writing, with proof of purchase and evidence of the original purchase date. Marley will then recommend an appropriate course of action.

Scope of the guarantee

- Subject to the conditions and exclusions above and provided that any claim is made within the Guaranteed Period, if any Products supplied breach this Guarantee, we will, at our option, provide replacement Product or refund the Product's original purchase price.
- This Guarantee is given to "consumers" as defined in, and who have the rights under, the Consumer Guarantees Act 1993 and should be read with the statutory consumer guarantees contained in that Act. This Guarantee is not intended to exclude, restrict or modify a consumer's rights under the Consumer Guarantees Act 1993.
- There may be some colour variation between existing Product and new Product supplied for replacement. Marley do not guarantee that any replacement Product will be an exact colour match to the original Product.
- Nothing expressed or implied in this Guarantee will confer any liability on Marley for any indirect, consequential or special loss or damage directly or indirectly resulting from any breach of this Guarantee.

Marley is committed to creating environmentally sustainable processes and products and was the first plastics manufacturer in New Zealand to achieve ISO14001 registration. We are also Best Environmental Practice certified for our entire range of manufactured uPVC systems.



Sustainable Manufacturing

Marley is committed to creating environmentally sustainable processes and products and was the first plastics manufacturer in New Zealand to achieve ISO14001 registration. We are also Best Environmental Practice certified for our entire range of manufactured uPVC systems. This means we get our raw materials from sustainable and responsible sources, continuously work on our manufacturing processes to reduce our environmental footprint and accept our products back at the end of their useful life for recycling.



 FOLLOW US @MARLEYNEWZEALAND

DISCLAIMER

This sales brochure has been compiled by Marley New Zealand Limited ("The Company") and is supplied subject to acknowledgment of the following conditions:

The sales brochure is protected by Copyright and may not be copied or reproduced in any form or by any means in whole or in part without prior consent in writing by the Company. Prices are subject to change, product specifications, usage data and advisory information may also change from time to time with advances in research and field experience. The Company reserves the right to make such changes to price or product information at any time without notice. Correct usage of the Company's products involve engineering judgements which cannot be properly made without full knowledge of all the conditions pertaining to each specific installation. The Company expressly disclaims all and any liability to any person whether supplied with this publication or not in respect of anything and of the consequences of anything done or omitted to be done by any such person in reliance whether whole or partial upon the whole or any part of the contents of this publication. No offer to trade, nor any conditions of trading, are expressed or implied by the issue or content of this manual. Nothing herein shall override the Company's Conditions of Sale, which may be obtained from the Registered Office or any Sales Office of the Company. This price book is and shall remain the property of the Company, and shall be surrendered on demand to the Company.

MAR3164 April 2018

OUR PARTNERS



For more information: **0800 MARLEY (0800 627539)**

www.marley.co.nz

an *Aliaxis* company

Rainwater Solutions

 **MARLEY**[®]