

Spouting & Downpipe

DIY Installation Guide



DIY
made easy!

Let's get started...

Marley has been making spouting and downpipes for kiwis for over 50 years. Proudly made in New Zealand, Marley spouting and downpipe systems offer clean lines and a smart finish that will enhance the look of your home and protect it against nature's elements.

Step 1: Select

PAGE

Spouting profiles 1

Downpipe profiles 1

Step 2: Plan

Plan your installation 2

Step 3: Prepare

What you will need 4

Step 4: Install

Install your spouting 5

Install your downpipe 7

Maintenance & Repairs

Maintenance 8

Repair damaged spouting 8

Fix spouting creep 8

Hi I'm Jack.

You may remember me from the Marley TV commercials in the late 80's-early 90's. I'll be your DIY guide providing helpful tips throughout this installation guide.



15 YEAR
GUARANTEE



WILL NOT
RUST



U.V
RESISTANT



MADE
IN NZ



SAFE FOR
DRINKING



LOW
MAINTENANCE



100%
RECYCLABLE

Which style is right for me?

Marley offers a wide range of spouting and downpipe profiles to suit a variety of house styles and rainfall levels. Choose from our most popular residential profiles below.

Spouting Profiles



Classic™ 

The original Roman profile, suits villas and colonial houses.

Brackets: Internal



FL2® 

Clean design with high front to hide untidy roof edges.

Brackets: Internal or External



Stormcloud®    

Versatile 1/4 round shape synonymous with Marley.

Brackets: Internal

NB: Flexipak only available for Stormcloud in Ironsand®, Grey Friars® and Black.



Typhoon®      

Contemporary half round design with large water capacity.

Brackets: Internal or External



Downpipe Profiles



RP65®
65MM ROUND
DOWNPIPE



RP80®
80MM ROUND
DOWNPIPE



65 x 50mm
RECTANGULAR
DOWNPIPE



100 x 50mm
RECTANGULAR
DOWNPIPE



Colour Key



Marley's range of uPVC downpipe systems can also be installed with metal spouting systems. Marley does not recommend installing its range of downpipes in wall cavities or in buried applications. Only Marley's round downpipe systems are to be used when installing a charged Rainwater collection system.



Selected non-stock items highlighted above can be ordered in custom quantities, utilising the Marley Flexipak service. Ask at your local merchant for more information.

For more detailed information relating to spouting and downpipe capacities refer to technical sections on each product page at marley.co.nz

Which components do I need?

Spouting

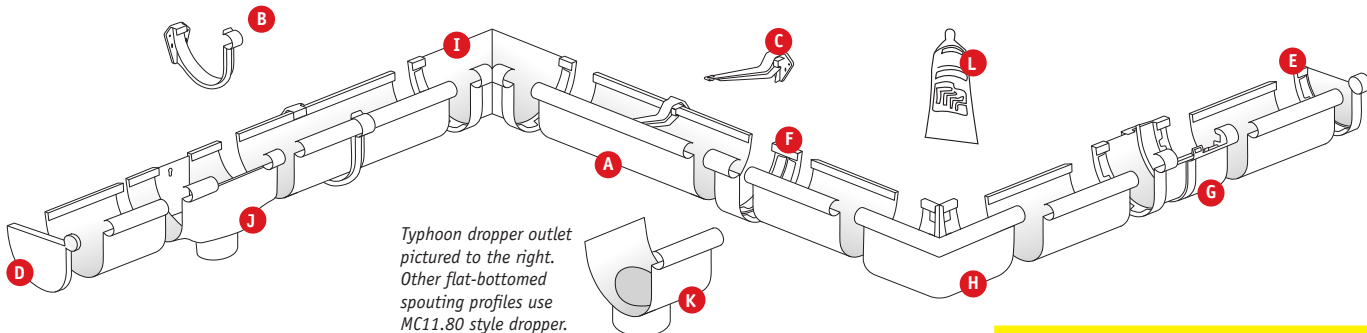

How much will I need?

Draw your roof with accurate measurements

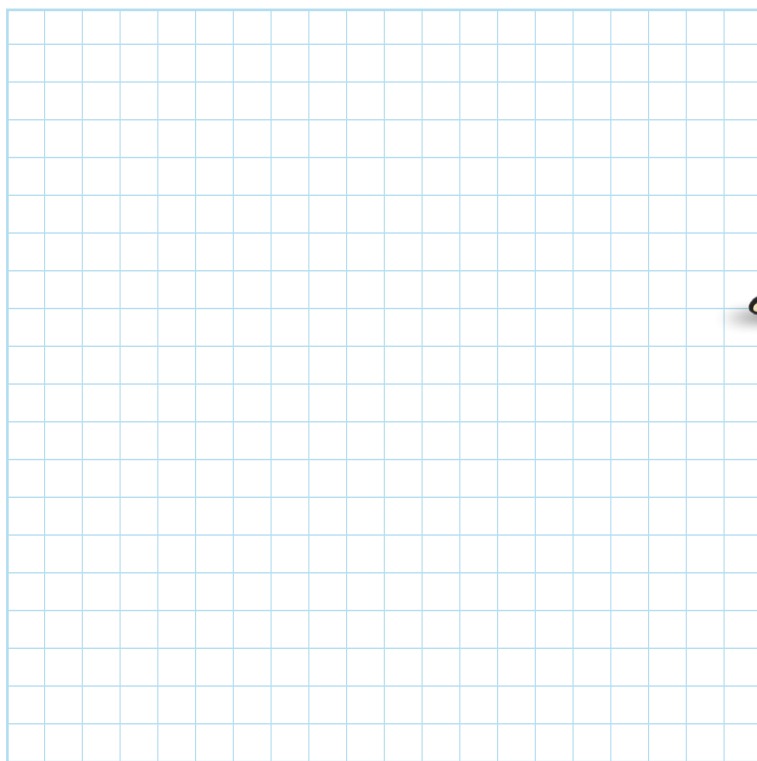

How big?

High rainfall areas, large houses or steep roofs may require a larger spouting profile to collect the rainwater and/or more downpipes to drain it!

If you are concerned about the current capacity or are replacing your entire spouting and downpipe system check the product technical page at marley.co.nz for the maximum capacity of each profile. Alternatively speak with your local merchant or call 0800 MARLEY for more advice.

Items I will need.

Item Code	Quantity	Item Code	Quantity

Downpipe

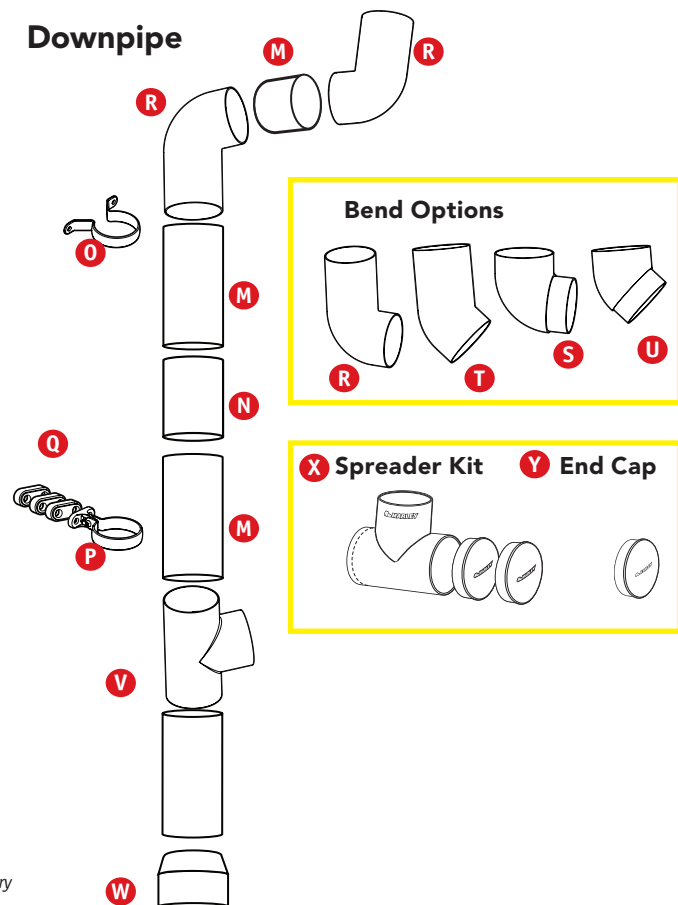

NOTE: Marley's Typhoon® spouting system and RP80® 80mm round downpipe systems have been used as examples in the diagrams shown on this page - shape, functionality and availability of components will vary depending on the specific spouting or downpipe system.

Spouting

Component	Classic™	FL2®	Stormcloud®	Stormcloud® Grey Friars®	Stormcloud® Ironsand®	Stormcloud® Black	Typhoon®	Typhoon® Grey Friars®	Typhoon® Ironsand®	Typhoon® Black	Typhoon® Copper	Typhoon® Titanium
A Spouting 3m length	MC1.3	FL1.3	MS1.3	-	-	-	MT1.3	-	-	-	-	-
A Spouting 4m length	-	-	-	MS1.4.GYF	MS1.4.IRO	MS1.4.BLK	-	MT1.4.GYF	MT1.4.IRO	MT1.4.BLK	MT1.4.COP	MT1.4.TTN
A Spouting 5m length	MC1.5	FL1.5	MS1.5	-	-	-	MT1.5	-	-	-	-	-
B External bracket	-	FL2E	-	-	-	-	MT2E	MT2E.GYF	MT2E.IRO	MT2E.BLK	MT2E.COP	MT2E.TTN
C Internal bracket	MC2	FL2I	MS2	MS2.GYF	MS2.IRO	MS2.BLK	MT2I	MT2I.GYF	MT2I.IRO	MT2I.BLK	MT2I.COP	MT2I.TTN
D Spouting Stopend (LH)	MC3	FL3	MS3	MS3.GYF	MS3.IRO	MS3.BLK	MT3	MT3.GYF	MT3.IRO	MT3.BLK	MT3.COP	MT3.TTN
E Spouting Stopend (RH)	MC4	FL4	MS4	MS4.GYF	MS4.IRO	MS4.BLK	MT4	MT4.GYF	MT4.IRO	MT4.BLK	MT4.COP	MT4.TTN
F Spouting joiner	MC5	FL5	MS5	MS5.GYF	MS5.IRO	MS5.BLK	MT5	MT5.GYF	MT5.IRO	MT5.BLK	MT5.COP	MT5.TTN
G Expansion joiner	MC17	FL17	MS17*	MS17.GYF	MS17.IRO	MS17.BLK	MT17	MT17.GYF	MT17.IRO	MT17.BLK	MT17.COP	MT17.TTN
H External corner 90°	MC6	FL6	MS6	MS6.GYF	MS6.IRO	MS6.BLK	MT6	MT6.GYF	MT6.IRO	MT6.BLK	MT6.COP	MT6.TTN
I Internal corner 90°	MC7	FL7	MS7	MS7.GYF	MS7.IRO	MS7.BLK	MT7	MT7.GYF	MT7.IRO	MT7.BLK	MT7.COP	MT7.TTN
J Expansion outlet 65mm	MC8.65	FL8.65	MS8.65	MS8.65.GYF	MS8.65.IRO	MS8.65.BLK	-	-	-	-	-	-
J Expansion outlet 80mm	MC8.80	FL8.80	MS8.80	MS8.80.GYF	MS8.80.IRO	MS8.80.BLK	MT8.80	MT8.80.GYF	MT8.80.IRO	MT8.80.BLK	MT8.80.COP	MT8.80.TTN
K Dropper outlet 65mm (only short runs)	MC11.65	MC11.65	MC11.65	-	-	-	-	-	-	-	-	-
K Dropper outlet 80mm (only short runs)	MC11.80	MC11.80	MC11.80	-	-	-	MT11.80	MT11.80.GYF	MT11.80.IRO	MT11.80.BLK	MT11.80.COP	MT11.80.TTN
K Dropper outlet 100mm (only short runs)	aMC11.100.50	MC11.100.50	MC11.100.50	-	-	-	-	-	-	-	-	-
L Marley MCS® Solvent Cement (180g tube)	MCS	MCS	MCS	MCS.GYF	MCS.IRO	MCS.BLK	MCS	MCS.GYF	MCS.IRO	MCS.BLK	MCS.COP	MCS.TTN

NOTE: Custom made spouting special angles are available upon request. Create a template, labelling where fascia is, with accurate measurements of the angle, indicating the Marley spouting profile; plus if it is an internal or external angle. Take the template into your nearest Marley stockist. Delivery will take 7-10 working days.

*The new Stormcloud® expansion joiner has specific installation. Please refer to www.marley.co.nz for details.

Downpipe

Component	Rectangular 65 x 50mm	Rectangular 100 x 50mm	RP65® 65mm Round	RP80® 80mm Round	RP80® Grey Friars®	RP80® Ironsand®	RP80® Black	RP80® Copper	RP80® Titanium
M Downpipe	MC16 (not socketed)	MC140 (not socketed)	RP65	RP80	RP80.GYF (not socketed)	RP80.IRO (not socketed)	RP80.BLK (not socketed)	RP80.COP (not socketed)	RP80.TTN (not socketed)
N Downpipe joiner	MC14	MC149	RS65	RS80	RS80.GYF	RS80.IRO	RS80.BLK	RS80.COP	RS80.TTN
O Saddle pipe clip	MC22	MC144	RC65	RC80	RC80.GYF	RC80.IRO	RC80.BLK	RC80.COP	RC80.TTN
P Adjustable pipe clip	MC22S	MC144S	RC65.2	RC80.2	RC80.2.GYF	RC80.2.IRO	RC80.2.BLK	RC80.2.COP	RC80.2.TTN
Q Adjustable pipe clip spacer	-	-	RC80.25	RC80.2S	RC80.2S.GYF	RC80.2S.IRO	RC80.2S.BLK	RC80.2S.COP	RC80.2S.TTN
R F+F bend - 95°	MC13	MC142	RB2.65	RB2.80	RB2.80.GYF	RB2.80.IRO	RB2.80.BLK	RB2.80.COP	RB2.80.TTN
S M+F bend - 95°	-	-	-	RB4.80	RB4.80.GYF	RB4.80.IRO	RB4.80.BLK	RB4.80.COP	RB4.80.TTN
T F+F bend - 43°	MC12 (112°)	MC145 (45°)	RB3.65	RB3.80	RB3.80.GYF	RB3.80.IRO	RB3.80.BLK	RB3.80.COP	RB3.80.TTN
U M+F bend - 43°	-	-	-	RB5.80	RB5.80.GYF	RB5.80.IRO	RB5.80.BLK	RB5.80.COP	RB5.80.TTN
V Junction - 95°	MC20 (112°)	MC148T	RJ65	RJ80	RJ80.GYF	RJ80.IRO	RJ80.BLK	RJ80.COP	RJ80.TTN
W Transition adaptor to round - 65mm	MC19.65	-	-	-	-	-	-	-	-
W Transition adaptor to round - 80mm	MC19.80	MC141.80	RA65.80	RAS80 (AHI 80mm)	-	-	-	-	-
W Transition adaptor to round - 90mm	-	MC141.90	RA65.90	RA80.90	RA80.90.GYF	RA80.90.IRO	RA80.90.BLK	RA80.90.COP	RA80.90.TTN
W Transition adaptor to round - 100mm	-	-	-	RA80.100	RA80.100.GYF	RA80.100.IRO	RA80.100.BLK	RA80.100.COP	RA80.100.TTN
X Spreader kit	-	-	-	SKIT80	SKIT80.GYF	SKIT80.IRO	SKIT80.BLK	SKIT80.COP	SKIT80.TTN
Y End Cap	-	-	-	CS80	CS80.GYF	CS80.IRO	CS80.BLK	CS80.COP	CS80.TTN

Accessories

Component	Item Code	Grey Friars®	Ironsand®	Black	Copper	Titanium
Galvanised nails	MCNAILS	-	-	-	-	-
Outlet Strainer	RWST	-	-	-	-	-
Untrapped Rainwater Gully	1SD6166	-	-	-	-	-
Curve® Leaf Diverter	CURVE	CURVE.GYF	CURVE.IRO	CURVE.BLK	CURVE.COP	CURVE.TTN
Twist® Rainwater Diverter	TWIST	TWIST.GYF	TWIST.IRO	TWIST.BLK	TWIST.COP	TWIST.TTN
Downpipe Diverter	RWDD	-	-	-	-	-

What will I need?

Tools

- ✓ String line/chalk line
- ✓ Drill and drill bit for screws
- ✓ Builders level
- ✓ Measuring tape
- ✓ Hacksaw – fine tooth PVC saw
- ✓ Hammer
- ✓ Ladder/trestle/planks
NB: Refer to [Worksafe NZ website](#) for best practice guidelines for working at height in New Zealand
- ✓ Pencil

Safety precautions

- Keep tools and materials away from children
- Read the instructions before beginning your project
- You may need to seek permission from your local council and/or water and power authorities before beginning the project
- When connecting downpipes to stormwater pipes, Marley recommend you consult a certified tradesperson before beginning the project
- Always work from a stable platform and only use ladders for access or to carry out low-risk minor or routine work.



Here's a quick lesson on how to use solvent cement

Solvent cement your fittings

Marley MCS® solvent cement is specifically formulated to bond together the components of Marley spouting and downpipe systems and helps to ensure a long-lasting, water tight joint is achieved. Only use Marley solvent cement (MCS®) when installing Marley spouting and downpipe.

1



Surface areas to be joined must be clean, dry and free from burrs.

2



Marley solvent cement (MCS®) should be applied evenly to **both surfaces** being joined. Then press both surfaces together and hold for 20-30 seconds

3



Any surplus solvent cement should be removed immediately with a damp, clean, lint free cloth. Leave sitting for 10 minutes.

How do I install my spouting?

Marley spouting and downpipes are intuitively designed as a modular system, making repair and replacement much simpler. There is a technical element to installing Marley spouting. If you are unsure, Marley recommends you seek advice from a trade professional.



Gather

Your tools and materials.



Set up

Assemble your scaffold and drop cloth around your work area and ensure appropriate safety equipment is at hand. Check the roof overhang beyond fascia is no less than 50mm.



Low points

Locate position of downpipe outlet, this will be your low point. On existing houses these are identified by existing downpipes or stormwater outlets.



String line/Chalk line

Next find your high point. Position the first bracket at determined high point as high as possible on the fascia under roof overhang. Secure string line to fascia using a screw adjacent to the first bracket and run under first bracket to the low point (see Fig 1). **Ensure a min fall of 5mm for every 10m of run.**

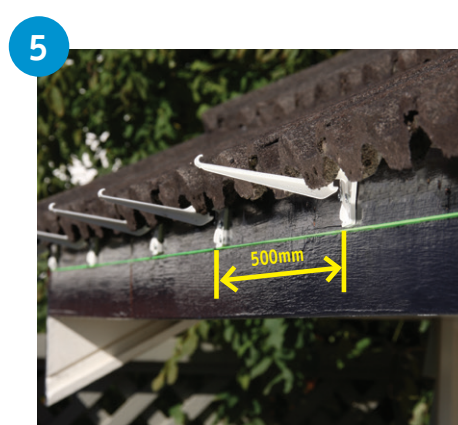

Brackets

Mark and secure brackets no more than 500mm apart. In high wind or snow prone areas reduce spacing to 300mm.

Use a minimum of 3 nails or 3 stainless steel screws per bracket. Minimum screw is 6g x 20mm coarse thread.

NB: Gib clouts must NOT be used.



Expansion Outlet (low point)

Position outlet at low point (in line with drain) and ensure string line aligns with feature on side tabs of outlet.

Secure outlet to fascia using a minimum of 4 fixings.

My Top Tips

- ✓ Add a Marley Curve to each downpipe to improve tank water quality or prevent drain blockages.
- ✓ Add a Marley Twist to your downpipes to capture free rainwater for watering, cleaning or emergency.
- ✓ Remember to double-check your lengths - measure twice, cut once.
- ✓ Work towards your low point (where drain is located) with a minimum fall of 5mm for every 10m.
- ✓ If you're going to paint spouting it's easier to paint on the ground before you install. See page 9 for paint recommendations.
- ✓ When replacing existing spouting, take the opportunity to check the condition of your fascia and sand/repaint as necessary.



Spouting

For internal brackets, position front of spouting into front of brackets, then roll spouting into back of brackets until secure.

For external brackets, position back of spouting into back of bracket, then roll spouting into front of brackets until secure.

Check every bracket is correctly engaged.



Expansion Allowance

Slide spouting into expansion outlet. Ensure end of spouting is aligned with the marking corresponding to the temperature at time of installation.

NB. Do not solvent weld spouting into expansion outlet.



Joins

Use spouting joiners and Marley MCS® solvent cement to connect lengths of spouting as necessary. For long runs over 16 metres or runs without an expansion outlet, replace one of the spouting joiners with an expansion joiner to provide further expansion allowance.

NB. The new Stormcloud® expansion joiner requires a different installation. Refer to www.marley.co.nz for details.



Corners

When required, solvent weld corners onto correct end of the spouting.

NB. Corners should be supported by brackets either side – 50mm clearance for external corners and 200mm clearance for internal corners.



Check

Check project is safe and complete. Clean any excess Marley solvent cement (MCS®) from corners or joiners to minimise potential pooling of water. Ensure spouting is correctly secured to each bracket and space has been provided for expansion and contraction.

Note:

Marley spouting systems are not designed for use as an internal spouting system.

How do I install my downpipe?

Marley downpipe systems efficiently transfer rainwater from spouting to stormwater systems with a modular range of pipe and fittings to suit any situation.



1 Install expansion outlet as per spouting installation instructions.



2 Connect downpipe bend to expansion outlet using a screw to hold bend in place. To allow easy removal for cleaning debris do not solvent cement bend to outlet.



3 Determine the offset length (A) using Fig 2 allowing for depth of socket and taking into consideration the downpipe bracket distance from the wall (B). Cut downpipe as per measurements.



4 Solvent cement all remaining elbows to downpipe on ground, before completing offset installation.



5 Use a level or plumb line to mark where the downpipe will sit against the wall. Ensure downpipe clips are spaced no more than 1.2 metres apart and the first clip is a maximum of 200mm below the downpipe bend. Downpipe clips to be secured with two stainless steel screws.



6 Connect downpipe to access pit, surface drainage or stormwater outlet (as shown in photo).

NB. Do not connect downpipe to waste water gully trap.

Check project is complete and all joints are clean.



Note

Marley downpipe systems are not designed for a concealed system, for use in wall or ceiling cavities or buried applications. Instead Stormwater/DWV pipe should be used for these applications.

Maintenance

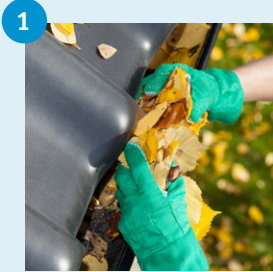

Clear debris

Regularly check and clear debris from the inside of your spouting and/or downpipes.

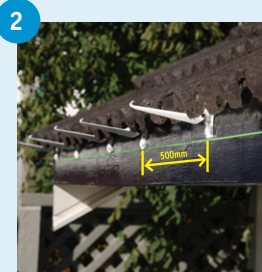

Check brackets

Check brackets are intact, spaced max 500mm apart and spouting has **even fall towards** outlet to avoid water ponding. (Min 5mm per 10m)



Check expansion joiner

Unclip expansion joiner, clean the rubber seal of any dirt or grit and re-lubricate with a silicone based lubricant before reassembly.



Clean once per year

Wash your Marley spouting and downpipe system annually using warm soapy water and a soft bristled brush or cloth. Rinse with clean water.



Painting

Clean spouting or downpipes and allow to dry. Apply mineral-based undercoat and two coats of acrylic paint.

NB. Do not paint inside of spouting or brackets, darker colours require additional expansion allowance.

Repairs

Repair damaged spouting



Block spouting with cloth to create dry working area. Mark and cut 50mm inside bracket either side of damaged area.



Replace any damaged brackets. Place joiner and expansion joiner then measure distance in between for replacement piece.



Cut replacement section on ground and solvent cement a joiner and expansion joiner to each end.



Roll the end with the expansion joiner into place by first engaging the back lip and then clicking front lip into position. Then solvent cement the joiner at the other end.

Fixing spouting creep



Spouting creep is when expansion and contraction does not occur in a conventional manner and may result in spouting pulling out of the expansion outlet or pushing into outlet and causing blockages.

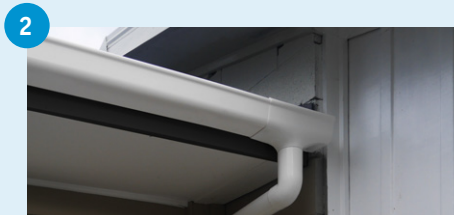

Re-insert spouting into expansion outlet. Ensure end of spouting aligns with temperature marking on inside face of outlet.



Secure spouting to fascia using a screw at the point furthest from the expansion outlet in the same run. This will control movement to and from the expansion outlet.

The New Era of Rainwater Harvesting

CURVE™

Drawing water in, keeping leaves out

- ✓ Filters leaves and debris for cleaner water
- ✓ Cleaner water into your tank improves water quality and reduces maintenance
- ✓ Reduces chance of your drains blocking
- ✓ Quick release upper body for easy maintenance
- ✓ Streamlined design with unique screen



TWIST®

Water when you need it

- ✓ Provides access to free rainwater from your downpipes
- ✓ Great source of water for the garden, to top up the pool or for emergency supply
- ✓ Positive impact on the environment through reduced mains water usage
- ✓ Filters leaves and debris for cleaner water



STRATUS®
DESIGN SERIES

Available in



White Grey Friars® Ironsand® Black Copper (Metallic) Titanium (Metallic)

Sustainable Manufacturing

Marley is committed to creating environmentally sustainable processes and products and was the first plastics manufacturer in New Zealand to achieve ISO14001 registration. We are also Best Environmental Practice certified for our entire range of manufactured uPVC systems. This means we get our raw materials from sustainable and responsible sources, continuously work on our manufacturing processes to reduce our environmental footprint and accept our products back at the end of their useful life for recycling.



 FOLLOW US @MARLEYNEWZEALAND

DISCLAIMER

This technical catalogue has been compiled by Marley New Zealand Limited ("The Company") to promote better understanding of the technical aspects of the Company's products to assist users in obtaining from them the best possible performance. The technical catalogue is supplied subject to acknowledgment of the following conditions:

The technical catalogue is protected by Copyright and may not be copied or reproduced in any form or by any means in whole or in part without prior consent in writing by the Company. Product specifications, usage data and advisory information may change from time to time with advances in research and field experience. The Company reserves the right to make such changes at any time without notice. Correct usage of the Company's products involve engineering judgements which cannot be properly made without full knowledge of all the conditions pertaining to each specific installation. The Company expressly disclaims all and any liability to any person whether supplied with this publication or not in respect of anything and of the consequences of anything done or omitted to be done by any such person in reliance whether whole or partial upon the whole or any part of the contents of this publication. No offer to trade, nor any conditions of trading, are expressed or implied by the issue or content of this manual. Nothing herein shall override the Company's Conditions of Sale, which may be obtained from the Registered Office or any Sales Office of the Company. This technical catalogue is and shall remain the property of the Company, and shall be surrendered on demand to the Company. Actual colours may vary slightly from those shown. For a more accurate colour comparison, please request a product sample.

MAR4035 Jan 2020

OUR PARTNERS



REGISTERED MASTER BUILDERS
**ASSOCIATE
MEMBER**



For more information: **0800 MARLEY (0800 627539)** | www.marley.co.nz

 **MARLEY**
by **alixis**